

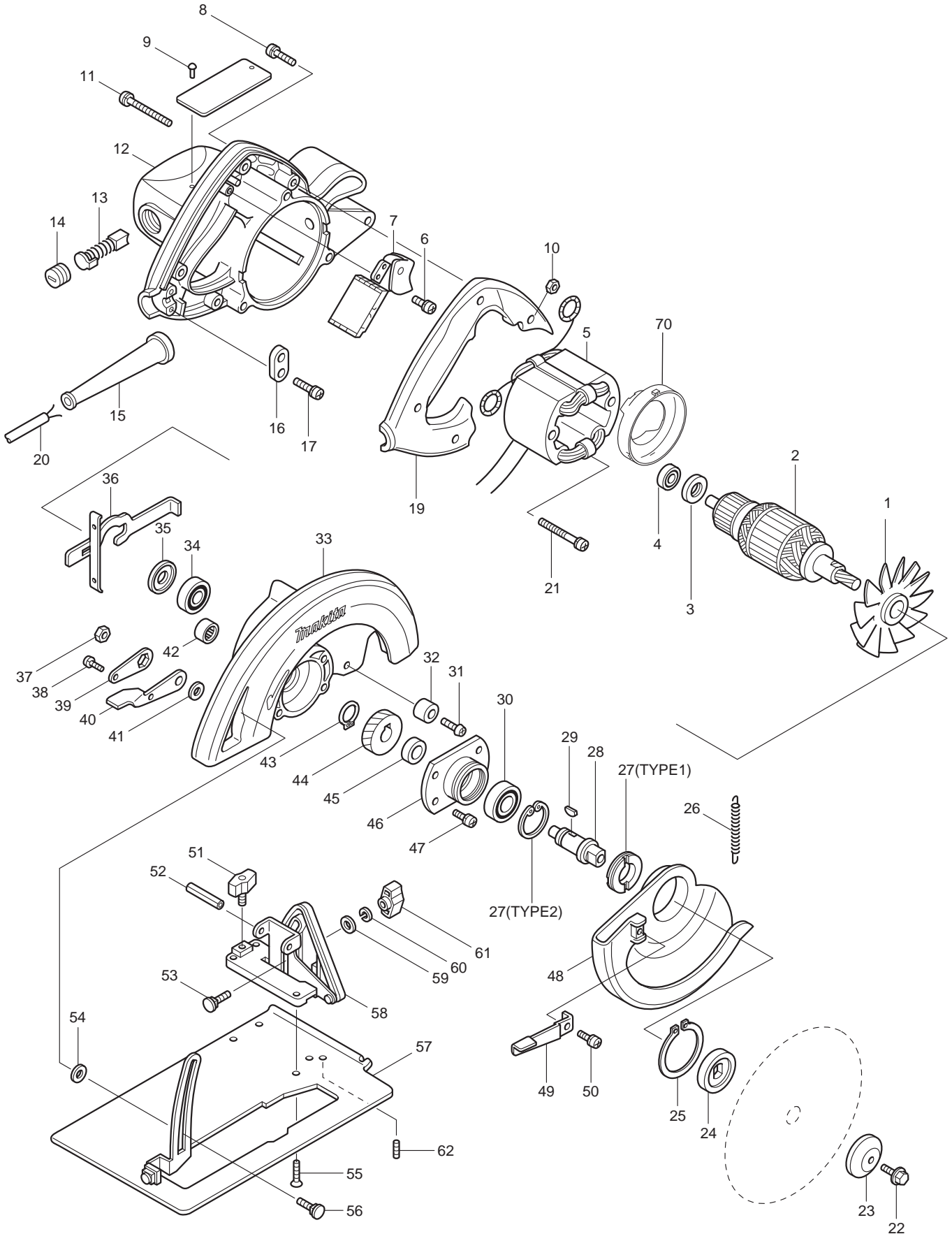

09 - 2008  
5007NBA / 5007NBA-K  
7 1/4" CIRCULAR SAW with BRAKE



Item No.	Ref.	Part No.	Description	Qty	Unit
1		241513-4	FAN 92	1	PC.
2	*	616606-0	ARMATURE ASS'Y	1	PC.
	INC.	*****	Item No. 1, 3, 4, 34 & 35		
3		681625-5	INSULATION WASHER	1	PC.
4		211033-2	BALL BEARING 608LB	1	PC.
5	*	636071-7	FIELD ASS'Y (TYPE3-4)	1	PC.
	INC.	654020-2	RING TERMINAL	2	PC.
	INC.	654502-4	CONNECTOR P-2	2	PC.
6	*	266020-6	TAPPING SCREW 4X12 (TYPE4)	1	PC.
7		651042-3	SWITCH 8670K2	1	PC.
8	*	265995-6	TAPPING SCREW 4X18 (TYPE4)	4	PC.
9		953106-2	RIVET 0-5 (OLD)	2	PC.
10		931102-0	HEX NUT M4 (OLD)	4	PC.
11		911273-9	PAN HEAD SCREW M5X50	3	PC.
12	*	156465-5B	MOTOR HOUSING COM. (TYPE2-3) - <b>N/L/A</b>	1	PC.
	INC.	643660-1	BRUSH HOLDER 6.5-13.5	2	PC.
	INC.	263002-9	RUBBER PIN 4	1	PC.
	*	152928-9	MOTOR HOUSING COM. (TYPE4)	1	PC.
	INC.	643660-1	BRUSH HOLDER 6.5-13.5 (TYPE1)	2	PC.
	INC.	643653-6	BRUSH HOLDER 6.5-13.5 (TYPE2)	2	PC.
13		181047-4	CARBON BRUSH CB-154(2PCS/SET)	1	SET
		181048-2	A.C. CARBON BRUSH CB-155(2PCS/SET)	1	SET
14		643650-4	BRUSH HOLDER CAP 6.5-13.5	2	PC.
15		682505-8	CORD GUARD 10-90	1	PC.
16	*	687063-9	STRAIN RELIEF (TYPE4)	1	PC.
17	*	265995-6	TAPPING SCREW 4X18 (TYPE4)	2	PC.
19	*	416889-0	HANDLE COVER (TYPE4)	1	PC.
20		664265-4	POWER SUPPLY CORD WITH PLUG 2P-16-2.5M (OLD#664213-3 - <b>N/L/A</b> )	1	PC.
21	*	266046-8	TAPPING SCREW 5X50 (TYPE4)	2	PC.
22		251644-1	HEX. FLANGE HEAD BOLT M8X20	1	PC.
23		224275-9	OUTER FLANGE 40	1	PC.
24		224151-7	INNER FLANGE 40	1	PC.
25		961201-4	RETAINING RING S-42	1	PC.
26		231806-7	TENSION SPRING 4	1	PC.
27	*	285807-7	BEARING RETAINER 22-36 (TYPE1)	1	PC.
	*	962153-2	BEARING RETAINER R-35 (TYPE2)	1	PC.
28	*	324256-4	SPINDLE (TYPE3)	1	PC.
29	*	254032-1	WOODRUFF KEY 5 (OLD)	1	PC.
30		211206-7	BALL BEARING 6202LLB	1	PC.
31		251247-1	+ PAN HEAD SCREW M6X20	1	PC.
32		262502-6	RUBBER SLEEVE 6	1	PC.
33	*	153436-3	BLADE CASE COMPLETE (TYPE4)	1	PC.
	INC.	213459-4	O RING 32	1	PC.
	INC.	321062-8	HOOK PIN (OLD)	1	PC.
	INC.		Item No. 42		
34		211106-1	BALL BEARING 6201LLB	1	PC.
35		213102-5	DUST SEAL 12	1	PC.
36		163113-9	SPINDLE LOCK	1	PC.
37		931402-8	HEX. NUT M8	1	PC.
38		911106-8	PAN HEAD SCREW M4X8	1	PC.
39		341415-5	LOCK PLATE	1	PC.

Item No.	Ref.	Part No.	Description	Qty	Unit
40		341416-3	LEVER PLATE	1	PC.
41		941201-0	FLAT WASHER 8	1	PC.
42		212052-1	NEEDLE BEARING 1010	1	PC.
43		961055-9	RETAINING RING S-15	1	PC.
44	*	226532-1	HELICAL GEAR 39 (TYPE2-3)	1	PC.
45		257064-7	RING 15	1	PC.
46	*	316700-5	BEARING BOX (TYPE2)	1	PC.
47		911126-2	PAN HEAD SCREW M4X16	4	PC.
48	*	317436-9	SAFETY COVER (TYPE3-4)	1	PC.
49		341417-1	LEVER	1	PC.
50	*	266026-4	TAPPING SCREW BIND CT 4X12 (TYPE2-4)	1	PC.
51		251858-2	SCREW M6X15	1	PC.
52		951225-8	SPRING PIN 6-40	1	PC.
53		251920-3	CAP SQUARE NECK BOLT M6X30	1	PC.
54	*	267113-2	FLAT WASHER 12 (TYPE3-4)	1	PC.
55		912212-2	COUNTERSUNK HEAD SCREW M5X12	4	PC.
56	*	266249-4	CAP SQUARE NECK BOLT M8X24 (TYPE3-4)	1	PC.
57	*	163378-3	BASE (TYPE3-4)	1	PC.
58		163246-0	ANGULAR PLATE (GOLD)	1	PC.
		163248-6	ANGULAR PLATE (SILVER))	1	PC.
59		941151-9	FLAT WASHER 6	1	PC.
60		942151-2	SPRING WASHER 6	1	PC.
61		252624-0	WING NUT M6	1	PC.
62		265882-9	- SCREW M5X12 (TYPE1)	1	PC.
		266180-4	+ SCREW M5X12 (TYPE2)	1	PC.
		266213-5	H.S.SET SCREW(FLAT POINT)M5X12 (TYPE3)	1	PC.
70	*	415603-1	FAN GUIDE (TYPE3-4)	1	PC.
100		652021-4	SCREW #5-40 (F/ TYPE1 SWITCH)	3	PC.
101		654001-6	SOLDERLESS EYE TERMINAL R1.25-3.5 (F/ SWITCH)	3	PC.
102		654510-5	CLOSED END CONNECTOR 5.5-SD	1	PC.
103	*	687080-9	FIELD CLAMP(TYPE3-4)	1	PC.
105		819003-1	MAKITA LABEL (OLD)	1	PC.

#### **ACCESSORIES**

A01		164095-8	GUIDE RULE	1	PC.
A02		781203-2	WRENCH 13 (TYPE1)	1	PC.
		782016-4	OFFSET WRENCH 13 (TYPE2)	1	PC.
A03		*****	7-1/4' C.T SAW BLADE (SEE CATALOGUE)	1	PC.
A04		125161-6	PLASTIC CARRYING CASE	1	PC.
	INC.	417700-9	HANDLE	1	PC.
	INC.	417902-7	LATCH	2	PC.

\* SEE SERVICE CHANGE

INC.=INCLUDES

**1. Service Change on Armature, Field, Motor Housing, etc.**

Item No.	Description	TYPE2	TYPE3	TYPE4
2	ARMATURE	614586-4 (N/L/A)	616606-0	
5	FIELD ASS'Y	524786-4	636071-7	
6	SCREW 4x12	911119-9 (P.H. SCREW)	266020-6 (TAPPING SCREW)	
8	SCREW	911148-2 (P.H.SCREW 4x25)	265995-6 (TAPPING SCREW 4x18)	
10	HEX NUT M4	931102-0		N/A
12	MOTOR HOUSING	156465-5A (N/L/A)	156465-5B (N/L/A)	152928-9
16	STRAIN RELIEF	687001-1		687063-9
17	SCREW 4x18	911131-9 or 911133-5 (P.H.SCREW)		265995-6 (TAPPING SCREW)
19	HANDLE COVER	411523-7A (N/L/A)	411523-7B	416889-0
21	SCREW	911280-2 (P.H.M5x55)	911676-7 (P.H.M5x55)	266046-8 (TAPPING SCREW Mx50)
70	FAN GUIDE	N/A	415603-1	
103	FIELD CLAMP	N/A	687080-9	

Above Parts are interchangeable as a set.

**2. Service Change on Bearing Box and Bearing Retainer**

Item No.	Description	TYPE1	TYPE2
27	BEARING RETAINER/ RETAINING RING	285807-7	962153-2
46	BEARING BOX	321061-0 (N/L/A)	316700-5

Above Parts are interchangeable as a set.

**3. Service Change on Blad Case and Safety Cover etc.**

Item No.	Description	TYPE1	TYPE2	TYPE3	TYPE4
33	BLADE CASE	154254-2 (N/L/A)	153303-2 (N/L/A)	153531-9(N/L/A) or 153543-1(N/L/A)	153436-3
48	SAFETY COVER	316244-5 (N/L/A) 4mm dia. Thread hole	316962-5 (N/L/A) 3mm dia.no thread hole	317436-9	
50	SCREW	911111-5 (P.H.M4x10)	266026-4 (TAPPING SCREW, CT4x12)		
54	FLAT WASHER	253069-5 (ID=12mm)	267096-6 (ID=8mm)	267113-2 (ID=12mm)	
56	C.H.BOLT M8X24	251918-0	265965-5	266249-4	
57	BASE	163177-3 (N/L/A)	163249-4 (N/L/A)	163378-3	
105	MAKITA LABEL	N.A	N.A	819003-1	

Above Parts are interchangeable as a set.

ID = Inside Diameter

**4. Service Change on Spindle**

Item No.	Description	TYPE1	TYPE2	TYPE3
28	SPINDLE	323789-6 (OLD#321060-2)	324044-9 (N/L/A)	324256-4
29	WOODRUFF KEY5	254032-1	N.A	N.A
43	RETAINING RING	961055-9	N.A	961055-9
44	HELICAL GEAR 39	221647-9 (N/L/A)	226532-1	